

22 June 2018

LICENSING AND SAFETY COMMITTEE – 3 JULY 2018

A meeting of the Licensing and Safety Committee will be held at 6pm on Tuesday 3 July 2018 in the Council Chamber, Town Hall, Rugby.

Adam Norburn
Executive Director

A G E N D A

PART 1 – PUBLIC BUSINESS

1. Minutes.
To confirm the minutes of the:

Licensing and Safety Committee 21 March 2018 and 17 May 2018; and
Licensing Sub-Committee (General) 15 May 2018.
2. Apologies.
To receive apologies for absence from the meeting.
3. Declarations of Interest.
To receive declarations of –
 - (a) non-pecuniary interests as defined by the Council's Code of Conduct for Councillors;
 - (b) pecuniary interests as defined by the Council's Code of Conduct for Councillors; and
 - (c) notice under Section 106 Local Government Finance Act 1992 – non-payment of Community Charge or Council Tax.

Note: Members are reminded that they should declare the existence and nature of their non-pecuniary interests at the commencement of the meeting (or as soon as the interest becomes apparent). If that interest is a prejudicial interest the Member must withdraw from the room unless one of the exceptions applies.

Membership of Warwickshire County Council or any Parish Council is classed as a non-pecuniary interest under the Code of Conduct. A Member does not need to declare this interest unless the Member chooses to speak on a matter relating to their membership. If the Member does not wish to speak on the matter, the Member may still vote on the matter without making a declaration.

4. Review of the policy for the licensing of multi-purpose vehicles (MPVs) as licensed hackney carriage and private hire vehicles.

PART 2 – EXEMPT INFORMATION

There is no business involving exempt information to be considered.

Any additional papers for this meeting can be accessed here via the website.

The Reports of Officers are attached.

Membership of the Committee: Councillors Cade (Chairman), Mrs Avis, Mrs Bragg, Brader, Miss Dumbleton, Mrs Garcia, Keeling, Mrs Nash, Picker, Mrs Roberts, Mrs Roodhouse and Ms Watson-Merret

If you have any general queries with regard to this agenda please contact Linn Ashmore, Democratic Services Officer (01788 533522 or e-mail Linn.Ashmore@rugby.gov.uk). Any specific queries concerning reports should be directed to the listed contact officer.

If you wish to attend the meeting and have any special requirements for access please contact the Democratic Services Officer named above.

AGENDA MANAGEMENT SHEET

Report Title:	Review of the policy for the licensing of multi-purpose vehicles (MPVs) as licensed hackney carriage and private hire vehicles
Name of Committee:	Licensing and Safety Committee
Date:	3 July 2018
Report Director:	Head of Environment and Public Realm
Portfolio:	Environment and Public Realm
Ward Relevance:	N/A
Prior Consultation:	N/A
Contact Officer:	Ian Rushton, Licensing Officer x3855
Public or Private:	Public
Report subject to Call-In:	No
Report En-Bloc:	No
Forward Plan:	No
Corporate Priorities:	Protect the public
Statutory / Policy Background:	The licensing of hackney carriage and private hire vehicles is regulated by the Town Police Clauses Act 1847 and Local Government (Miscellaneous Provisions) Act 1976. The Council's Taxi Licensing Policy (2009) sets out the local standards and requirements in respect of vehicle licensing, and this report aims to update the MPV specification part of the policy. The full policy is to be reviewed in its entirety in due course.

Summary:	The current MPV specification is over 9 years old and has been reviewed to bring it up to date. An updated MPV specification has been drafted and is attached to this report.
Financial Implications:	There are no direct financial implications in respect of this report. Costs can be awarded against the Council in the event that a licensing decision is challenged and overturned in Court.
Risk Management Implications:	There are no risk management implications for this report
Environmental Implications:	There are no environmental implications for this report.
Legal Implications:	Need to comply with Local Government (Miscellaneous Provisions) Act 1976 and Town Police Clauses Act 1847. A policy can be subject to a judicial review.
Equality and Diversity:	There are no equality and diversity implications for this report
Options:	To approve or refuse to approve the revised MPV specification.
Recommendation:	That this matter is considered and the proposed revised MPV specification is approved.
Reasons for Recommendation:	The current MPV specification is out of date and needs to be updated and improved.

Licensing and Safety Committee - 3 July 2018

Review of the policy for the licensing of multi-purpose vehicles (MPVs) as licensed hackney carriage and private hire vehicles

Report of the Head of Environment and Public Realm

Recommendation

That the Committee consider this matter and approve the updated specification for the licensing of MPV's as shown at Appendix 2.

1. BACKGROUND

1.1 The licensing of hackney carriage and private hire vehicles is regulated by the Local Government (Miscellaneous Provisions) Act 1976 and the Town Police Clauses Act 1847. In terms of private hire vehicles, the legislation defines a private hire vehicle as a motor vehicle constructed or adapted to carry fewer than eight passengers, other than the hackney carriage or public service vehicle, which is provided for hire with the services of the driver for the purposes of carrying customers. Before a licence is granted the Authority must be satisfied that the vehicle is:

- suitable in type, size and design for the use as a private hire vehicle;
- not of such design and appearance as to lead any person to believe that the vehicle is a hackney carriage;
- in a suitable mechanical condition;
- safe and;
- comfortable.

1.2 The Council's Taxi Licensing Policy (2009) sets out the local standards and requirements in respect of vehicle licensing, and this report aims to update the MPV specification part of the policy. All other parts of the policy remain the same including the requirement that any new hackney carriages must be brand new and wheelchair accessible.

2. THE MPV SPECIFICATION

2.1 The current MPV specification (see **Appendix 1**) was introduced in April 2009 and is in need of an update. Officers have reviewed it and a proposed revised specification is shown at **Appendix 2**. The key changes are the proposed removal of the requirements in respect of tip-up seats not being permitted – these are requirements 11, 13 and 15 on the current specification. It is proposed

to replace these to formally allow the use of tip-seats (as appropriate) in licensed vehicles.

- 2.2 The current specification states that any vehicles with tip-up seats will not be licensed. This is clearly out of date in today's market. Over the last few years, a number of different MPV's have been presented for licensing, the majority of which have had tip-up seats. On inspection, it was found that in most cases, the operation of the tip-up seat(s) was straight-forward and allowed ease of access to the rear seats, with no impact on passenger comfort. As a result, these vehicles being subsequently licensed.
- 2.3 There are now lots of different makes and models of MPVs on the market, many of which have tip up seats. The quality of the vehicles, and the quality of the tip up seats that are fitted, is improving all the time and so it is important that our MPV specification reflects this.
- 2.4 Officers recently inspected two MPVs (a Ford Connect Grand and a Fiat Doblo XL) which were provided by a company called Alfred Bekker Ltd. One of these vehicles was fitted with folding seats at the back - but these seats (which are standard size seats and not occasional use seats) are side-folding seats in that they are fitted to the sides of the vehicle and can be swung out for passengers to use them. This then allows wheelchairs to access the rear of the vehicle without the need for the rear seats to be moved or removed from the vehicle.
- 2.5 Officers are working with Alfred Bekker Ltd to arrange an assessment and demonstration of their wheelchair accessible vehicles including their 'flexi ramp'. This exercise will of course involve representatives from the Rugby Disability Forum. Details of these vehicles and the flexi ramp is attached at **Appendix 3** for information.
- 2.6 The current policy of not permitting small MPVs will continue. These include the Vauxhall Zafira and Volkswagen Touran. These are converted estate cars with a third row of seats. However, the seats are poor for comfort of passengers, access to the 3rd row seats is difficult due to the size of the vehicle and head height, and when the 3rd row of seats are in use, there is very little luggage space.
- 2.7 Applicants are always encouraged to contact Officers to discuss the licensing of an MPV in advance of their purchase to check and make sure that the vehicle can be licensed for the number of passengers that the applicant would like.
- 2.8 There has been no prior formal consultation with the trade regarding this policy. It is mainly a consolidation of recent decisions by Licensing and Safety Committee and reflects the current market in hackneys. A full review of the taxi policy is planned and the trade will be fully consulted then.

3. CONCLUSION

- 3.1 The Committee is asked to consider this report and to approve the revised MPV specification shown at Appendix 2.
- 3.2 The Council has discretion over the types of vehicle that can be licensed, and the Department for Transport Guidance suggests that best practice is for local licensing authorities to adopt the principle of specifying/allowing as many different types of vehicle as possible. The guidance encourages Authorities to allow the trade to put forward vehicles of their own choice which can be shown to meet basic criteria. In that way, emerging new designs for vehicles can be readily taken into account.

Name of Meeting: Licensing and Safety Committee

Date of Meeting: 3 July 2018

Subject Matter:

Review of the policy for the licensing of multi-purpose vehicles (MPVs) as licensed hackney carriage and private hire vehicles

Originating Department: Environment and Public Realm

BACKGROUND PAPERS

Document No.	Date	Description of Document	Officer's Reference	File Reference
1		Council Taxi Licensing Policy	IR	
2		Local Government (Miscellaneous Provisions) Act 1976, Town Police Clauses Act	IR	
3.		Best Practice Guidance issued by Dept for Transport	IR	

APPENDICES

Document No.	Description of Document	Officer's Reference	File Ref
Appendix 1	Current MPV specification	IR	
Appendix 2	Proposed MPV specification	IR	
Appendix 3	Details of vehicles from Alfred Bekker Ltd	IR	



APPENDIX 1

THE CURRENT MPV SPECIFICATION

POLICY FOR LICENSING OF MULTI PURPOSE VEHICLES (MPVs)

Supplementary Council Taxi and Private Hire Vehicles Conditions for all Licensed Hackney Carriage and Private Hire Vehicles, Including Multi-Purpose Vehicles

1. In respect of private hire vehicles, the vehicle must not be of such a design and appearance as to lead any person to believe or mistake it for a Hackney carriage.
2. To be licensed for the first time the vehicle must be in excellent mechanical and interior condition.
3. The vehicle must meet Rugby Borough Council's minimum vehicle requirements. These can be found in the Council's "Hackney Carriage & Private Hire Vehicles" Guide.
4. The vehicle must seat a minimum of 4 passengers in comfort.
5. The vehicle must have no more than 8 passenger seats.
6. The vehicle must have adequate legroom and luggage space to satisfy the comfort and requirements of all passengers.
7. The vehicle must be 'as manufactured' (i.e. as it came off the production line of the primary manufacturer). No additions or alterations, including resprays, are allowed unless the Rugby Borough Council Public Health and Licensing Team has given prior written approval. This approval will not be unreasonably withheld.
8. The vehicle must be right hand drive, except for stretched limousines which are imported from the USA.
9. The vehicle must have a minimum of 4 road wheels.
10. The vehicle must have a minimum of 4 passenger doors.

11. Each passenger must be able to exit the vehicle, without moving, tilting or climbing over the back of a seat, via a minimum of 2 doors situated on opposite sides of the vehicle. For front seat passengers, exit would be via either of two front doors situated on opposite sides of the vehicle. For rear seat passengers, the exit would be via either of two rear doors situated on different sides of the vehicle. (it is proposed to remove this requirement)
12. MPVs, which have seat configurations where all passengers can get out without having to tip or fold a seat, are permitted.
13. Tip-up seats, which must be tipped up for access to other rows of seats, are not permitted. (it is proposed to remove this requirement)
14. Tip-up seats in MPVs may be permanently removed, where the vehicle has them fitted, to allow compliance with these access requirements, subject to it not affecting safety. (it is proposed to amend this condition).
15. MPVs which have seat configurations where passenger to the rear of the driver can only get out of the vehicle though either tipping up or moving a seat or seats are not permitted. (it is proposed to remove this requirement)
16. Doors must be easy to open from outside and inside of the vehicle. Facing seats for hackney carriages and PHVs are permitted provided that seat belts are fitted for each seat.
17. Up to two passengers are permitted to sit in the front of the vehicle, beside the driver, provided that the gear lever does not impede the passenger, there are 2 clearly defined passenger seats, and that there are 3 point seat belts fitted to each seat.

PROPOSED UPDATED MPV SPECIFICATION

POLICY FOR LICENSING OF MULTI PURPOSE VEHICLES (MPVs)

Supplementary Council Taxi and Private Hire Vehicles Conditions for all Licensed Hackney Carriage and Private Hire Vehicles, Including Multi-Purpose Vehicles

Important notice to applicants

Before you commit to buying a particular vehicle, you are advised to contact the Council's Licensing Team to check and discuss the vehicle that you are interested in for licensing purposes.

1. In respect of private hire vehicles, the vehicle must not be of such a design and appearance as to lead any person to believe or mistake it for a Hackney carriage.
2. The vehicle must be in excellent mechanical and interior condition.
3. The vehicle must meet the Council's minimum vehicle requirements which can be found in the Council's "Hackney Carriage & Private Hire Vehicles" Guide within the Licensing Policy.
4. The vehicle must be able to seat a minimum of 4 passengers in comfort.
5. The vehicle must have no more than 8 passenger seats.
6. The vehicle must have adequate legroom and luggage space to satisfy the comfort and requirements of all passengers.
7. The vehicle must be 'as manufactured' (i.e. as it came off the production line of the primary manufacturer). No additions or alterations, including resprays, are allowed unless the Council has given its prior written approval. This approval will not be unreasonably withheld.
8. The vehicle must be right hand drive (except for stretched limousines and novelty type vehicles).
9. The vehicle must have a minimum of 4 road wheels.
10. The vehicle must have a minimum of 4 passenger doors.
11. Each passenger must be able to exit the vehicle via a minimum of 2 doors situated on opposite sides of the vehicle. For front seat passengers, exit would be via either of two front doors situated on opposite sides of the vehicle. For

rear seat passengers, the exit would be via either of two rear doors situated on different sides of the vehicle. (new proposed requirement)

12. MPVs with a seating layout where all passengers can get in and out of the vehicle without having to tip or fold a seat are permitted.
13. Vehicles which have seats that which must be tipped up or folded for access to other rows of seats, will be permitted if the seats can be easily tipped or folded, and access to the third row of seats is adequate and convenient (new proposed condition).
14. Tip-up seats in some MPVs may be permanently removed, where the vehicle has them fitted, to allow compliance with these access requirements, subject to there being no adverse impact on comfort or safety. This will reduce the number of passengers that the vehicle would be licensed to for (amended condition).
15. Seats which are designed for occasional or temporary use in vehicles will generally not be permitted. These type of seats may not provide sufficient room and comfort for passengers or sufficient luggage space, and access to the seats may not be adequate (new proposed condition).
16. Doors must be easy to open from inside and outside of the vehicle. Facing seats are permitted in licensed vehicles provided that seat belts are fitted for each seat.
17. Up to two passengers are permitted to sit in the front of the vehicle, beside the driver, provided that the gear lever does not impede the passenger(s), there are 2 clearly defined passenger seats, and that there are 3 point seat belts fitted to each seat.

FlexiRamp™

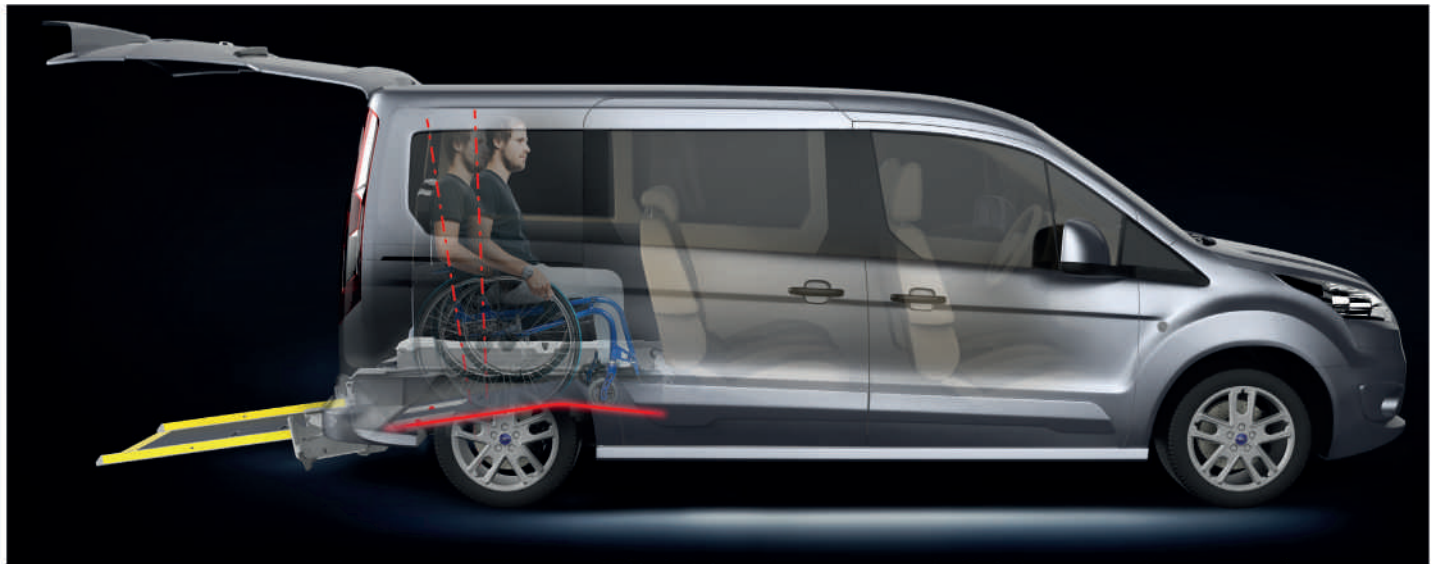

Conversions without limits



FlexiRamp™

→ UNIQUE ENTRANCE SYSTEM

FlexiRamp is synonymous for an easy and comfortable transport of a wheelchair user.

The vehicle floor is lowered full length and is equipped with the patented aluminium folding ramp. The floor and the ramp surface are non-slip and washable.

The retractable wheelchair restraint system ensures safety and security when a wheelchair is entering a vehicle and during transport.

The wheelchair accessible vehicle has variable seating capacity using the original seats.

AVAILABLE FOR VEHICLES:

BRL	Peugeot Partner, Citroën Berlingo
CDS	Volkswagen Caddy
CDM	Volkswagen Caddy Maxi
CNT	Ford Tourneo Connect
CNL	Ford Grand Tourneo Connect



FlexiRamp can be easily folded down returning the luggage compartment to its original configuration.

Optional equipment: winch assist, headrest, tip-up seats.



**European Community
Whole Vehicle Type Approval**

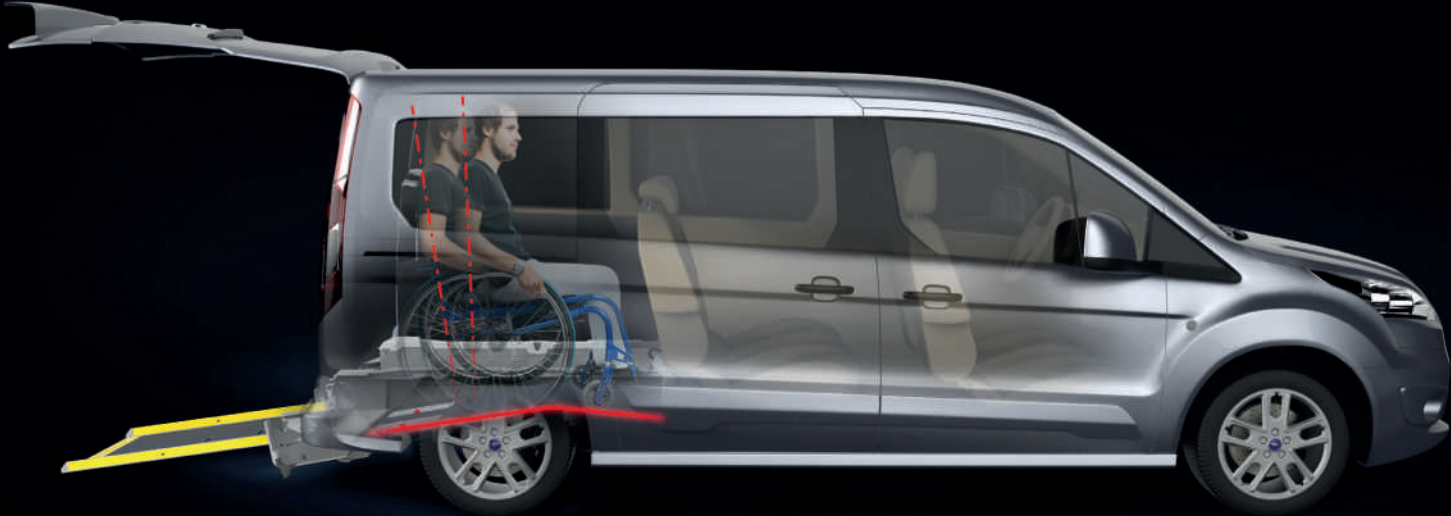

FlexiCurve floor allows a wheelchair user to find the most comfortable seating position and enjoy a pleasant driving experience.

Peugeot Partner, Citroën Berlingo FlexiRamp™



DIMENSIONS

A	entrance door height	1 450 mm	57,09 in
B	min. interior height	1 370 mm	53,94 in
C	ramp slope	12°	12°
D	ramp width	730 mm	28,74 in
E	ramp length	1 050 mm	41,34 in
F	floor width	760 mm	29,92 in
H	floor length	1 400 mm	55,12 in



SEATING CAPACITY

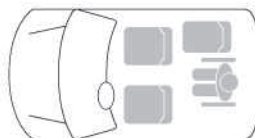
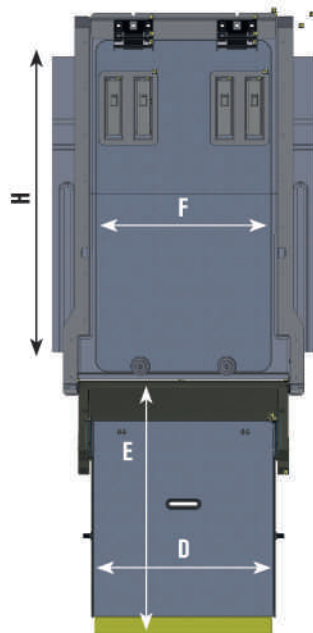

3 people + 1 wheelchair

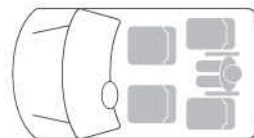

4 people + 1 wheelchair

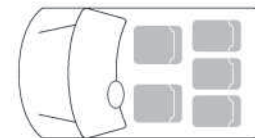

5 people



Volkswagen Caddy FlexiRamp™



DIMENSIONS

A	entrance door height	1 450 mm	57,09 in
B	min. interior height	1 420 mm	55,91 in
C	ramp slope	12°	12°
D	ramp width	750 mm	29,53 in
E	ramp length	1 270 mm	50,00 in
F	min. floor width	785 mm	30,91 in
G	max. floor width	1 030 mm	40,55 in
H	floor length	1 550 mm	61,02 in

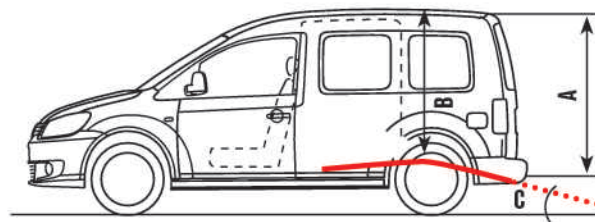

SEATING CAPACITY

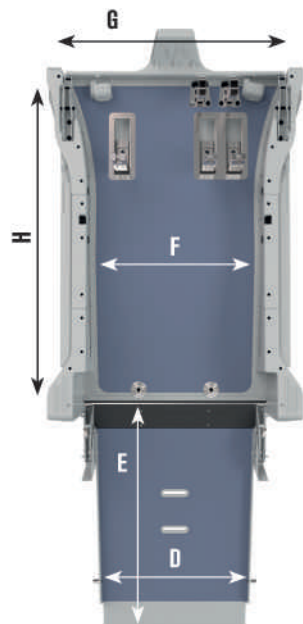

FlexiCurve floor

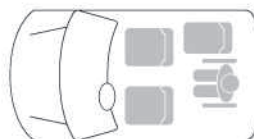

3 people + 1 wheelchair

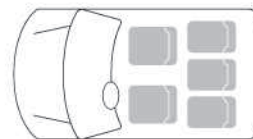

5 people



Volkswagen Caddy Maxi FlexiRamp™



DIMENSIONS

A	entrance door height	1 450 mm	57,09 in
B	min. interior height	1 420 mm	55,91 in
C	ramp slope	12°	12°
D	ramp width	725 mm	28,54 in
E	ramp length	1 140 mm	44,88 in
F	floor width	760 mm	29,92 in
H	usable floor length	1 400 mm	55,12 in

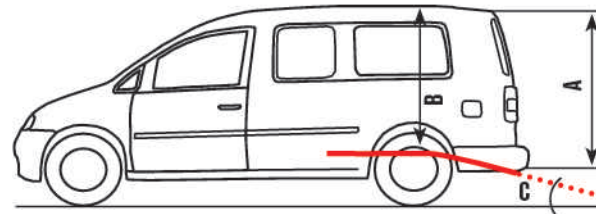

SEATING CAPACITY

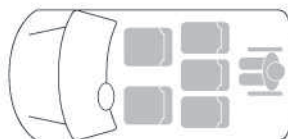
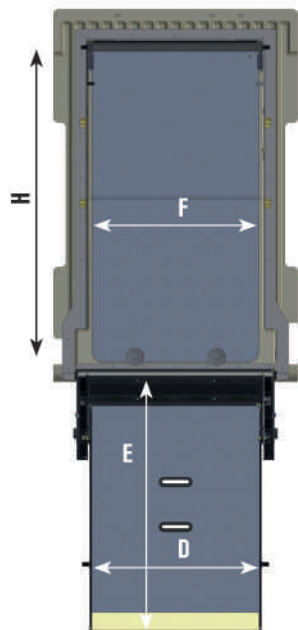

5 people + 1 wheelchair

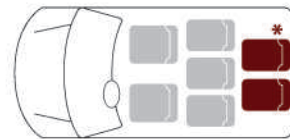

5 - 7 people



* ORIGINAL OR TIP-UP SEATS



Ford Tourneo Connect FlexiRamp™



DIMENSIONS

A	entrance door height	1 480 mm	58,27 in
B	min. interior height	1 370 mm	53,94 in
C	ramp slope	12°	12°
D	ramp width	765 mm	30,12 in
E	ramp length	1 100 mm	43,31 in
F	min. floor width	775 mm	30,51 in
G	max. floor width	860 mm	33,86 in
H	floor length	1 540 mm	60,63 in

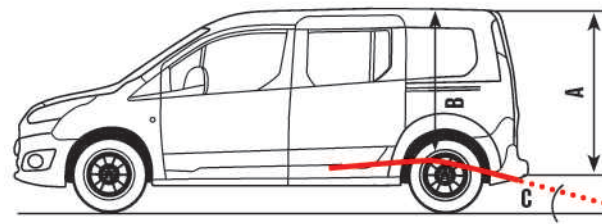

SEATING CAPACITY

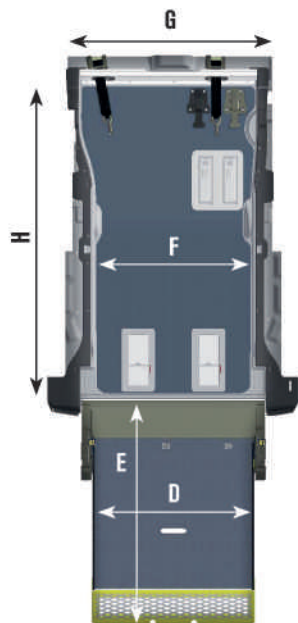

FlexiCurve floor

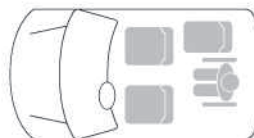

3 people + 1 wheelchair

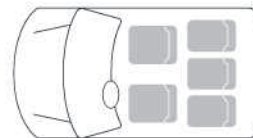

5 people



Ford Grand Tourneo Connect FlexiRamp™

DIMENSIONS

A	entrance door height	1 480 mm	58,27 in
B	min. interior height	1 370 mm	53,94 in
C	ramp slope	12°	12°
D	ramp width	765 mm	30,12 in
E	ramp length	1 290 mm	50,79 in
F	min. floor width	775 mm	30,51 in
G	max. floor width	860 mm	33,86 in
H	usable floor length	1 230 1 330 mm	48,43 52,36 in

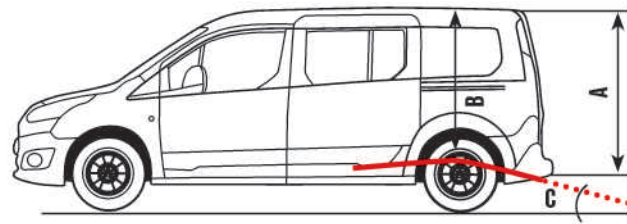

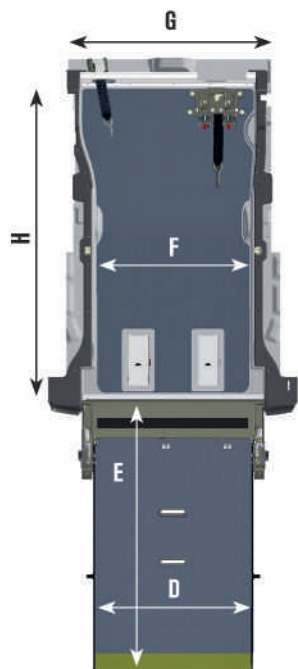

FlexiCurve floor

SEATING CAPACITY

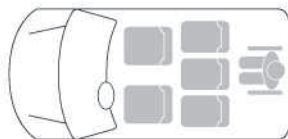

5 people + 1 wheelchair

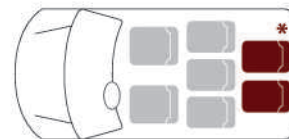

5 - 7 people



• TIP-UP SEATS



OPTIONAL EQUIPMENT

RESTRAINT SYSTEMS

Slide'n'Click retractors | standard



Flush mounted rear retractors | optional



HEADREST



TIP-UP SEATS



WINCH ASSIST



	BRL	CDS	CDM	CNT	CNL
SnC retractors	✓	✓	✓	✓	✓
FLR retractors				✓	✓
Headrest	✓	✓	✓	✓	✓
TIP-UP seats			✓		✓
Winch assist	✓	✓		✓	✓

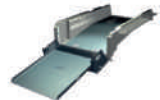
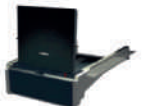

- **COMPREHENSIVE DEVELOPMENT**
- **FULL EU TYPE APPROVAL**
- **PRECISE PRODUCTION**
- **CUSTOMER SUPPORT**





CONTACT

www.alfredbekker.com



ALFRED BEKKER API LTD

Kelleythorpe Industrial Estate, Drifffield | East Yorkshire, YO25 9DJ
T: +44 1377 241700 F: +44 1377 241767 E: info@alfredbekker.com

www.alfredbekker.com



API CZ S.R.O.

Slapy 136, 391 76 Slapy u Tábora, **Czech Republic**
T: +420 381 278 043 M: +420 606 070 992
E: info@apicz.com www.apicz.com

API DE GMBH

Stubenrauchstraße 121, 12357 Berlin, **Germany**
T: +49(0)30-453 05 144 F: +49(0)30-453 05 161
E: contact@apicz.com www.apide.de



All pictures and illustrations shown are for reference purposes only. All information, specifications and illustrations are based on the latest information available at the time of publishing. Alfred Bekker API Ltd reserves the right to make changes at any time without notice. © 2016 Alfred Bekker API Ltd.

